

Technical  
Application Guide  
for LED T8 Batten  
LUZ-AL06-50W-B

# Introduction



T8 Batten series suitable for ceilings, walls or pendant mounting. AA12 prismatic diffuser for visual comfort. Cover plate held securely by threaded nut for fast installation. High quality white epoxy powder coated finish. Large terminal block for ease in installation. New plastic snap-on end caps for easy installation of diffuser.

- Up to 70% energy saving compared to standard CFL
- Long lifetime of 40,000 hours
- 120° wide beam angle
- CCT: 3000K 4000K  
5000K 5700K
- No UV/IR light
- Environment friendly, without Mercury or any other hazardous substances

## Application notes

- IP20 for indoor use only
- Professional electrician for installation only
- Switch off before installation
- Do not touch when in use
- Keep away from hot steam and corrosive gas

## Application Areas

All commercial, industrial and domestic applications

## Certificate



# Product Information

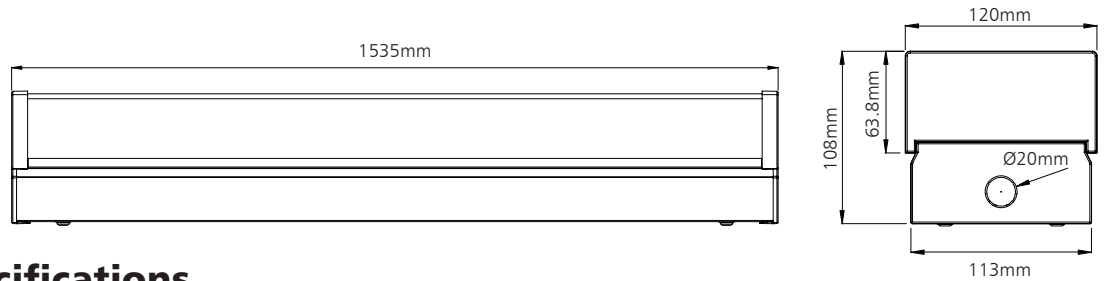

## Technical Specifications

Model	Voltage	Power	Power Factor	Lumen (±5%)	Beam angle	CCT	Lifespan	CRI	Dimmable	Dimension
LUZ-AL06-50W-B	AC100-277V	50W	≥0.9	4150	120°	3000K	40000h	≥80	No	1535*120*108mm
LUZ-AL06-50W-B	AC100-277V	50W	≥0.9	4250	120°	4000K	40000h	≥80	No	1535*120*108mm
LUZ-AL06-50W-B	AC100-277V	50W	≥0.9	4300	120°	5000K	40000h	≥80	No	1535*120*108mm
LUZ-AL06-50W-B	AC100-277V	50W	≥0.9	4250	120°	5700K	40000h	≥80	No	1535*120*108mm

## Driver data Sheet

Driver data	Non-dim
Input rated Voltage	AC100-277V
Frequency	50/60Hz
Input Voltage	AC90-305V
Efficiency	≥89%
Total load Wattage	50W±1W
Power Factor	≥0.9
Rated input current	≤0.55A
Full load output Voltage	DC60-75V
Rated output current	640mA
Output current range	640mA±5%
Power tolerance	±5%
Current output tolerance	±5%
Short circuit protection	PASS
Over voltage protection	PASS
Over temperature protection	PASS
Withstand voltage	AC1500V

## Fixture Compatibility

Rated Wattage	Electrical Classification	Ingress Protection	Operating Temp	Operating Humidity	Storage Temp
50W	I	IP20	-20°C~45°C	0~90%	-20°C~65°C

# Spectral Distribution

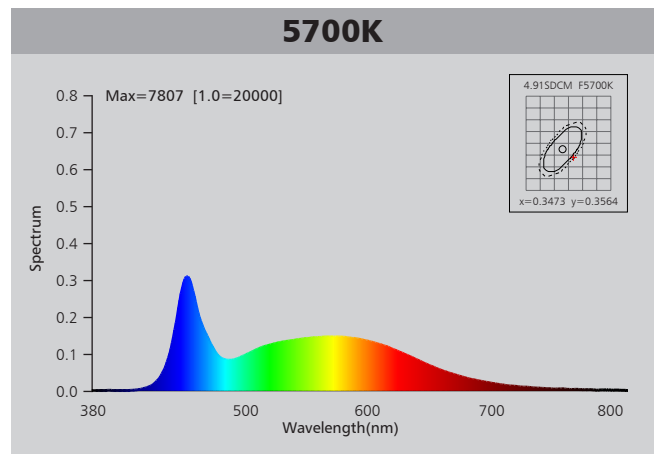
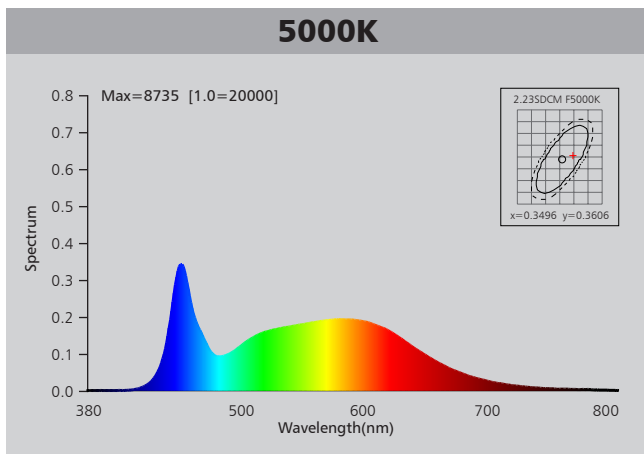
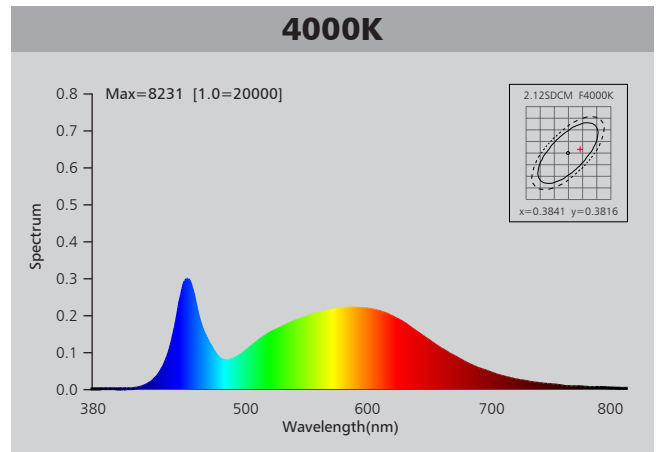
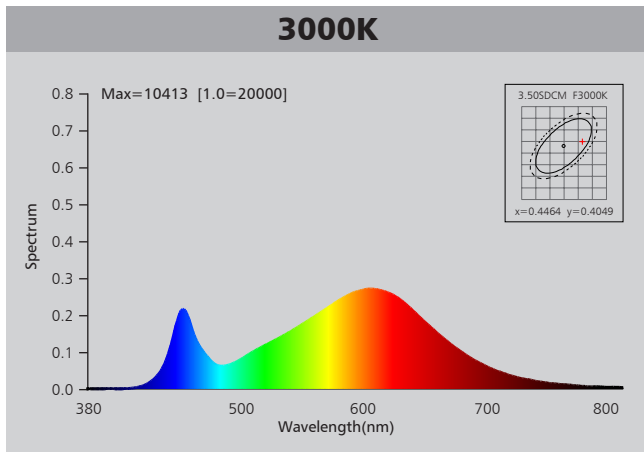

# Photometric Diagram

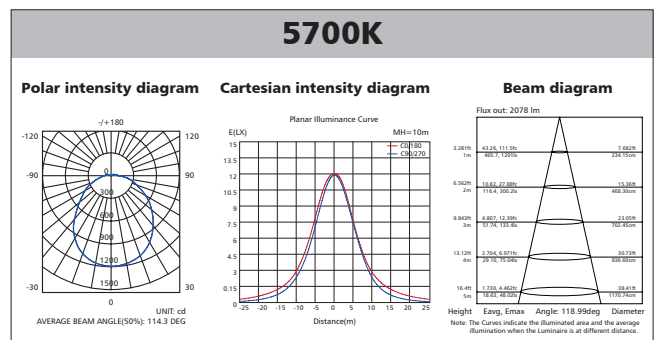
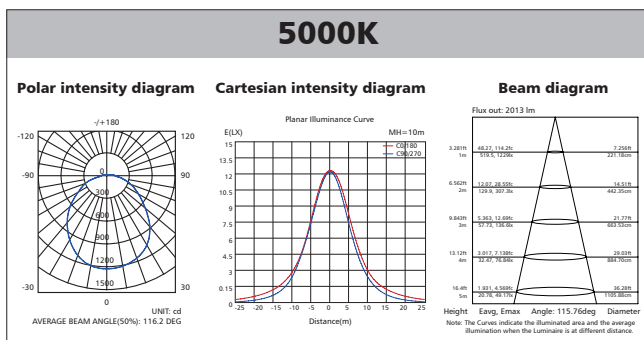
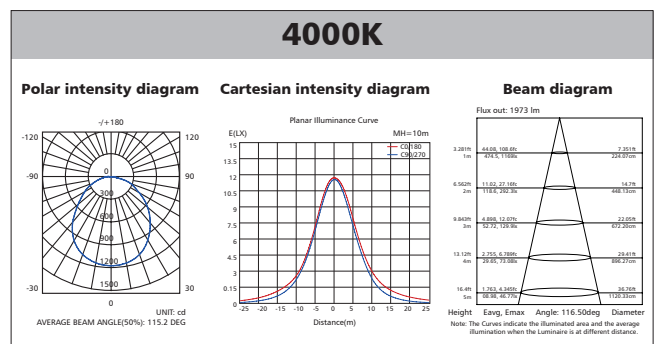
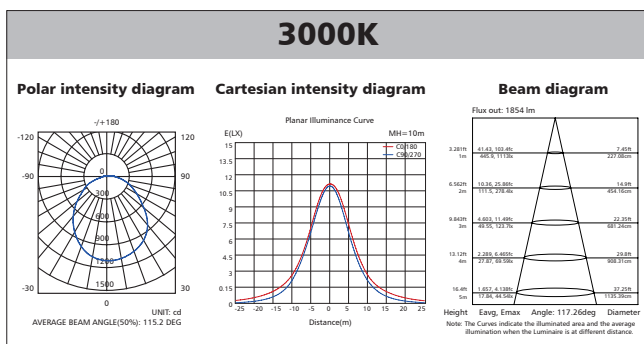

## Polar Diagram Comparison

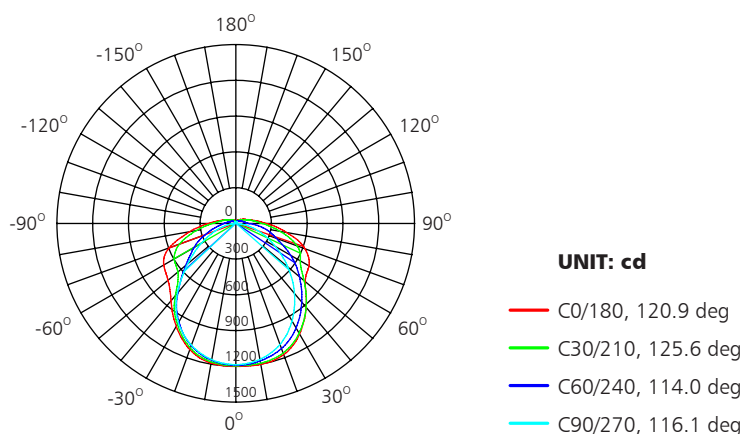

AVERAGE BEAM ANGLE (50%): 116.6DEG



## Driver lifetime & LED light decay rate

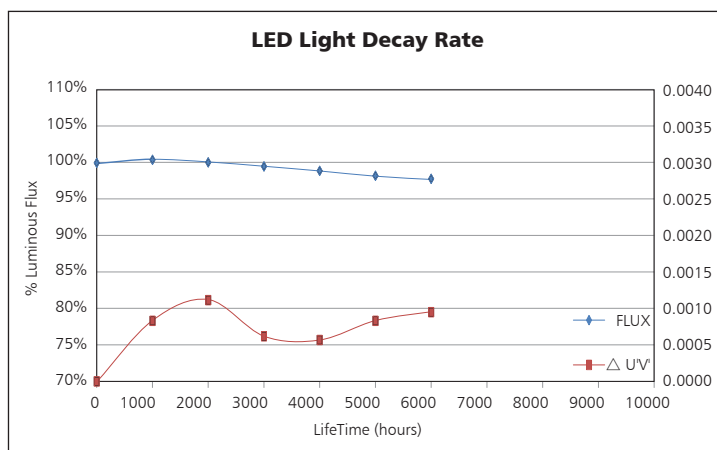
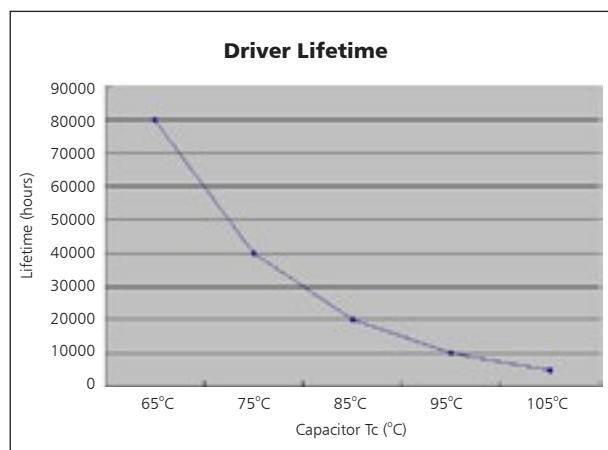

## Temperature

- The testing is operated at 25°C
- The lifetime of capacitor, minimum of 5,000 hours if operated at 105°C, will be doubled whenever the temperature drops 10°C
- The highest withstand temperature of IC, MOS could be 120°C
- The highest withstand temperature of LED junction temperature is 150°C

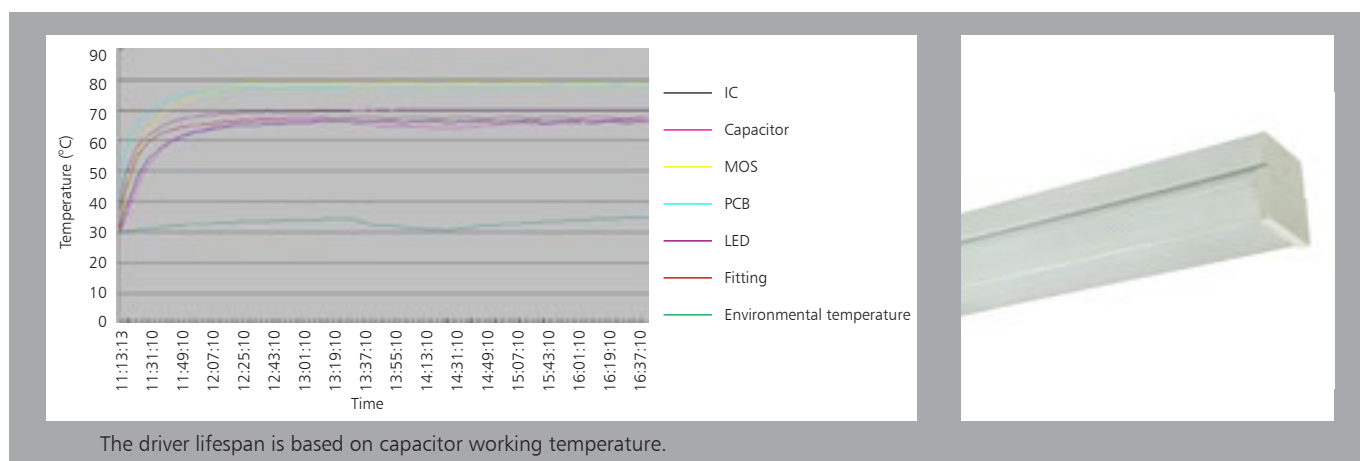

# Installation

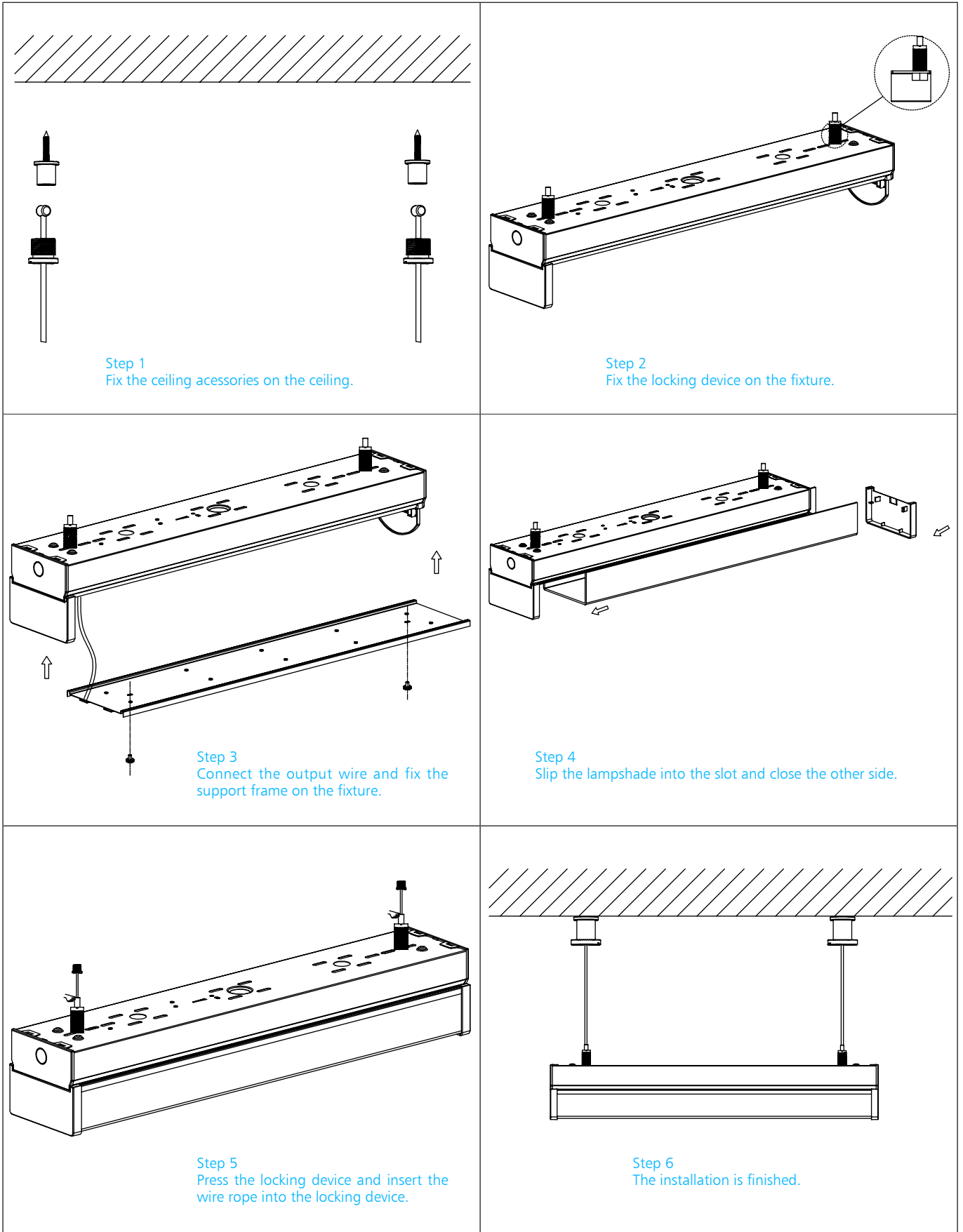

# Installation

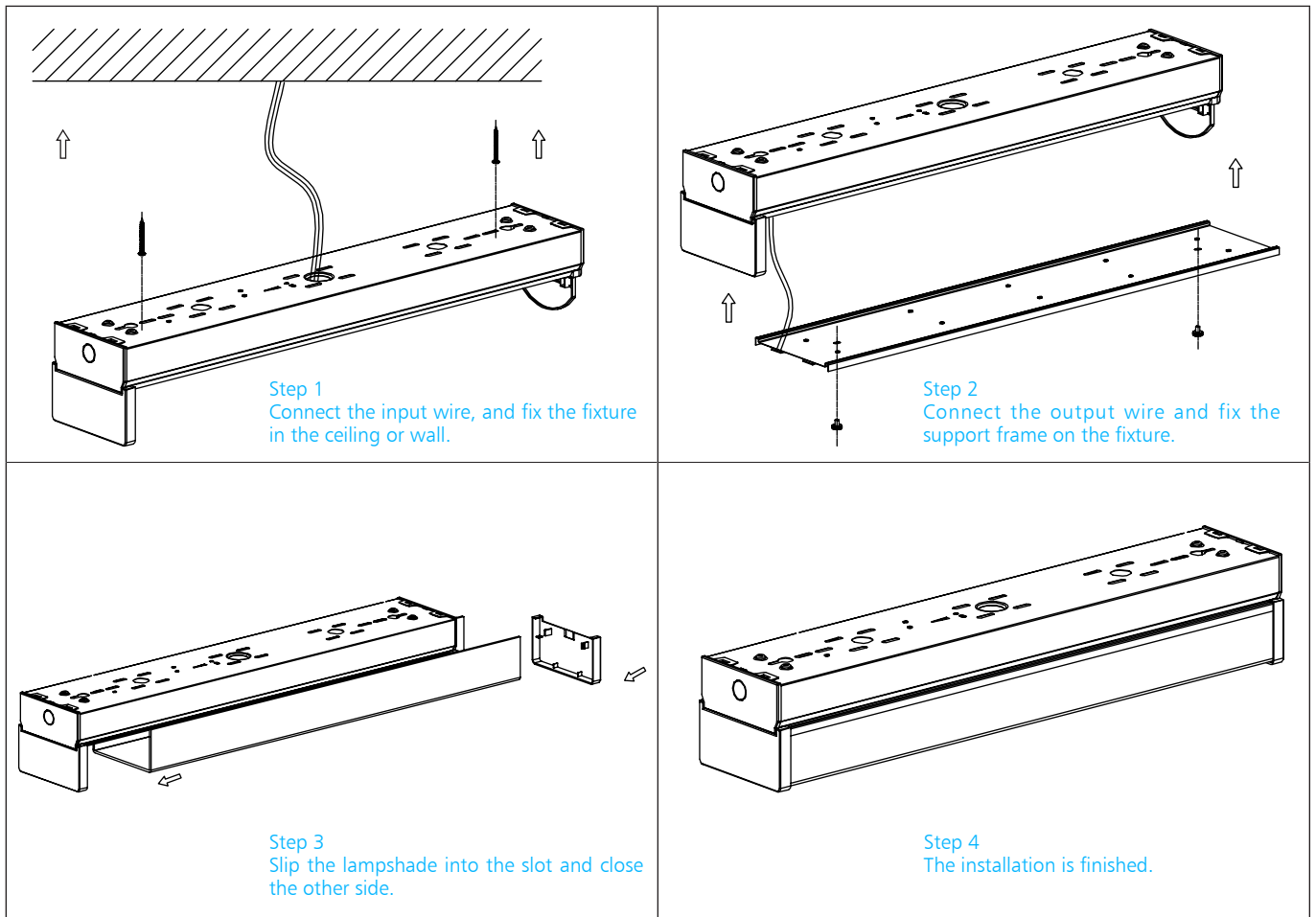

# Packaging Information

	SIZE(CM)	N.W/pc (KGS)	G.W.(KGS)	Q'TY(PCS)
Carton	156*27.5*26	4.5	19	4

	CTNS	Q'TY(PCS)	VOLUME(CBM)
20" standard container	230	920	28
40" standard container	460	1840	56

